

Filling your Subpod

Now that Subpod is in the ground, it's time to add some worms and bedding. (It is a garden 'bed' after all!)

Here's what you'll need:

- 2000+ composting worms with castings (500g / 1.1lb)
- Worm blanket, moistened (comes in the box)
- 8 good handfuls of 'bedding' material (pick any of the below):
 - Coir / coconut peat
 - Shredded newspaper
 - Subpod's cardboard packaging, torn into small pieces



1 Add bedding material

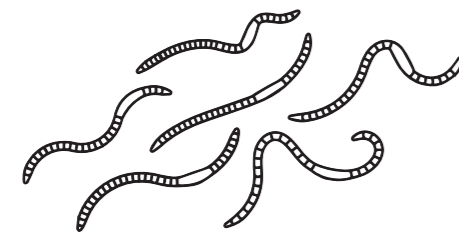

2 Add worms and castings

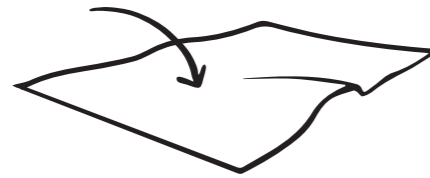

3 Add moist worm blanket

*Add all 3 ingredients on both sides of the internal divider

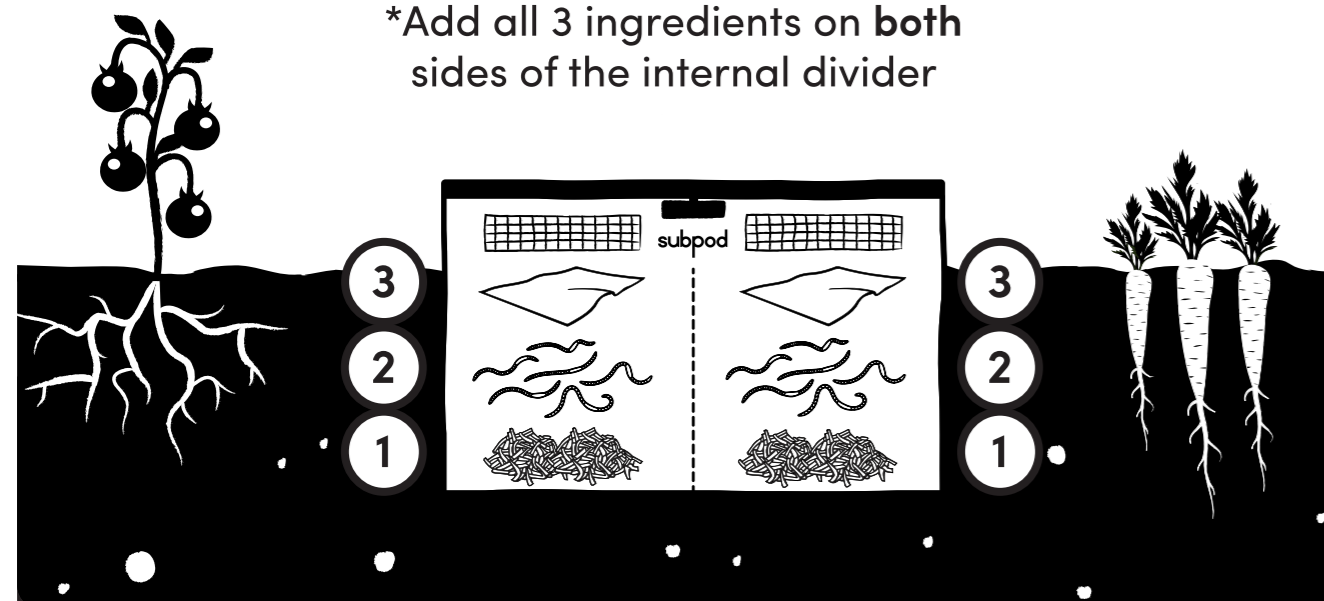

Well done! Time to take a seat! Why not take a few photos of your garden and share on social media! #subpod #compostunderground

subpod

Feeding your Subpod

Subpod is kind of like a child or a pet - only far less maintenance! So, it needs to be fed well and looked after to get the best results. Here's some general tips, and there's more inside your Subpod lid.

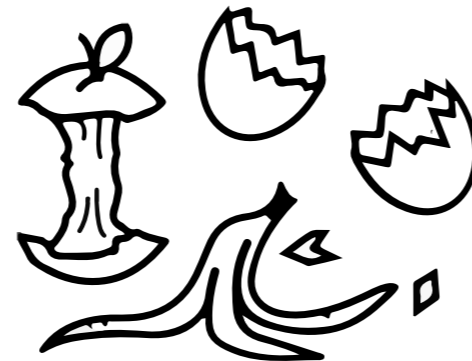

Add food scraps (don't overfeed)



Add dry carbon with each feeding

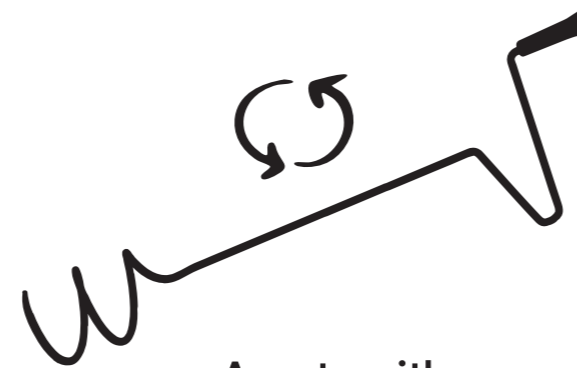

Aerate with each feeding

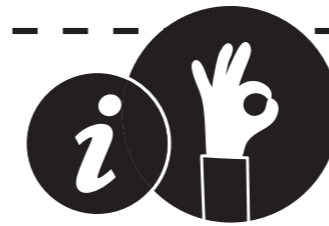

Refer to the inside of your Subpod lid for more info on feeding

Support

Visit www.subpod.com, or join the composting community at growhub.subpod.com for more helpful information and resources to improve your composting, and for one-on-one support.

Did you know?

A compost worm can eat its own weight in food waste every day!

Welcome to the Subpod family! Let's get started!

subpod

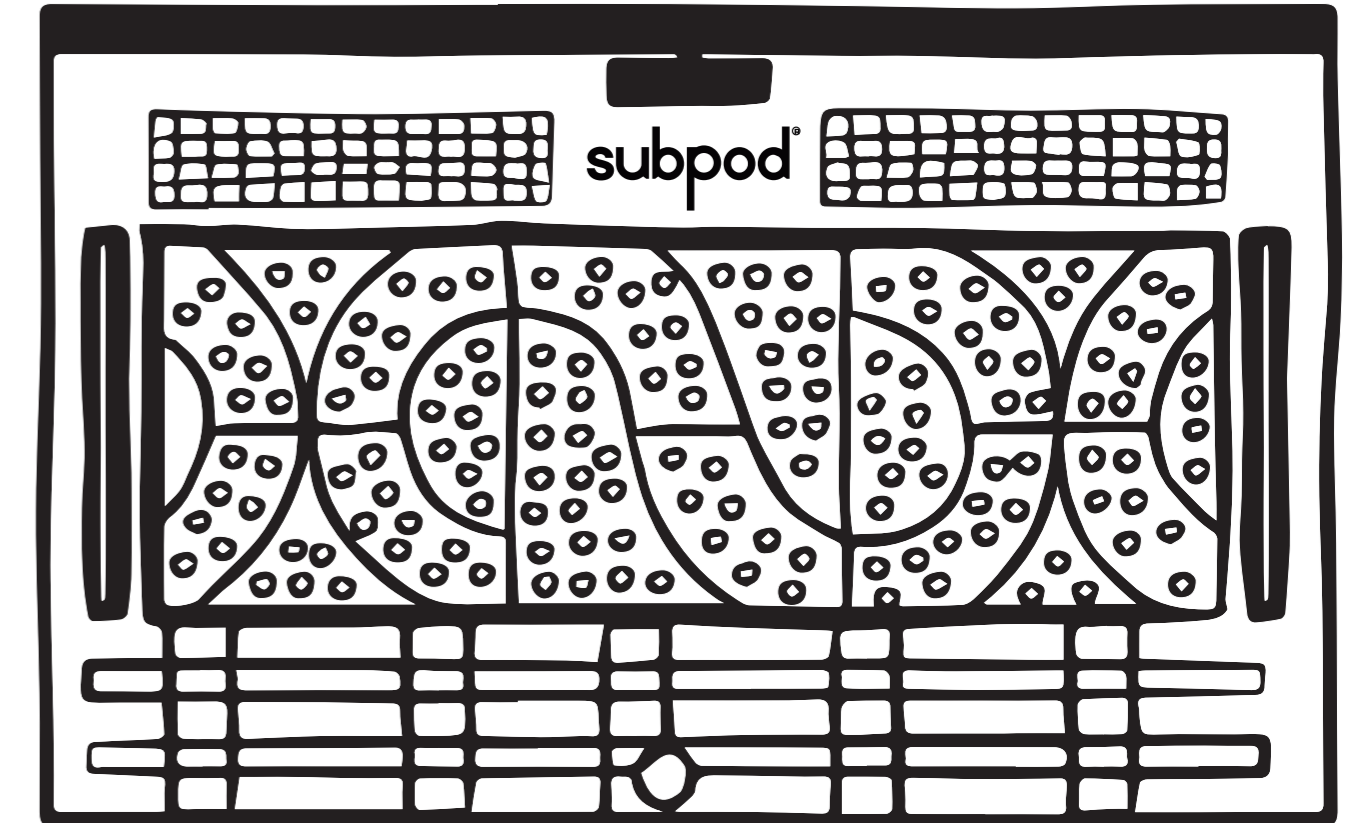

Four easy steps!

- 1 Assemble your Subpod
- 2 Plant it in your garden
- 3 Fill it with the essentials
- 4 Feed it with your waste



If you need more info during these steps, see our full online guide with images and video at subpod.com/start

Assembling your Subpod

Let's get Subpod in the ground!
Simply follow the steps below
or visit www.subpod.com/start
for more details.

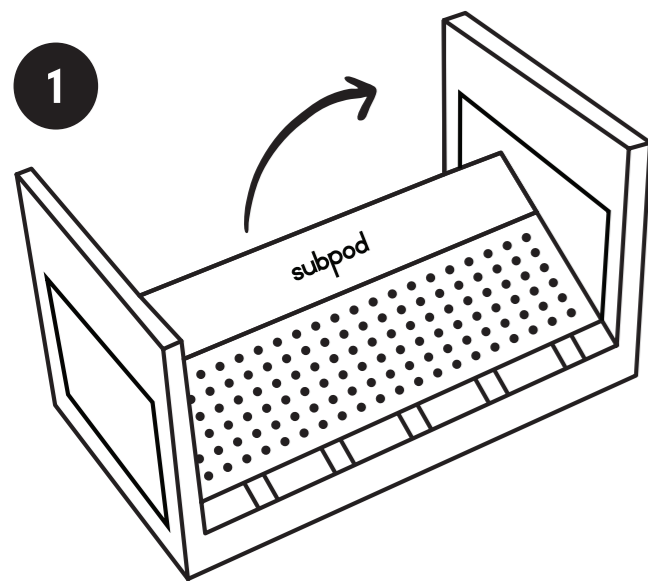

Unpack & Unfold

Unpack your Subpod from the box, then simply fold out the 4 panels from the base and push firmly until you hear the click at each corner.

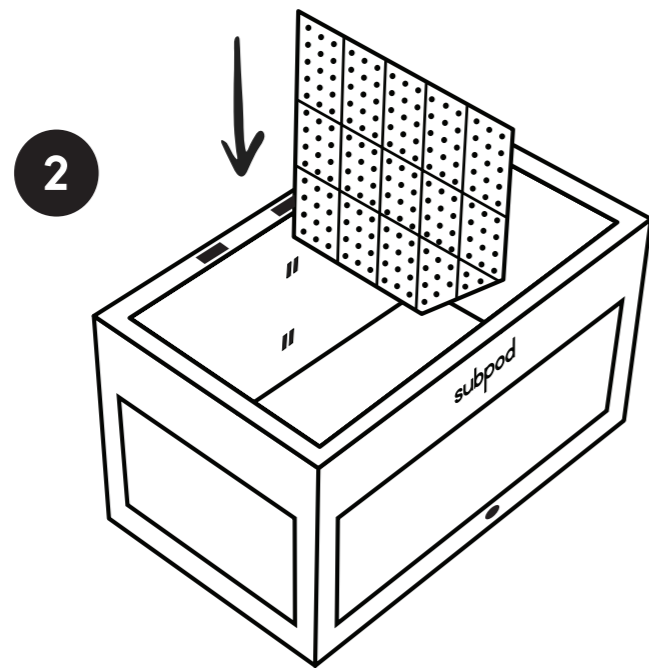

Insert Divider

Slot the internal divider panel as shown into the guides, which are located inside the Subpod in the middle.

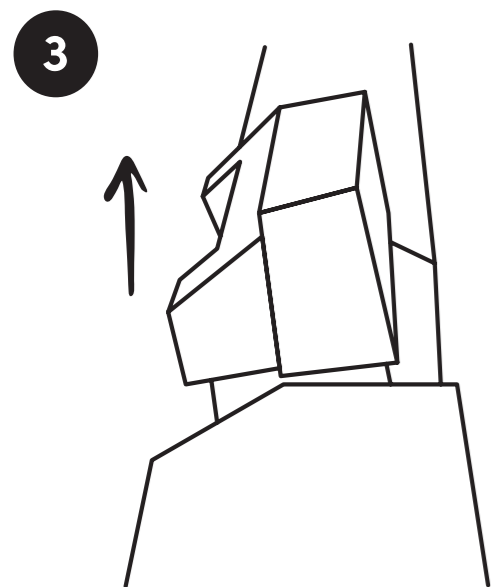

Stand Hinges Upwards

Make sure the 3 hinges on the rear wall of the Subpod are all standing upwards.

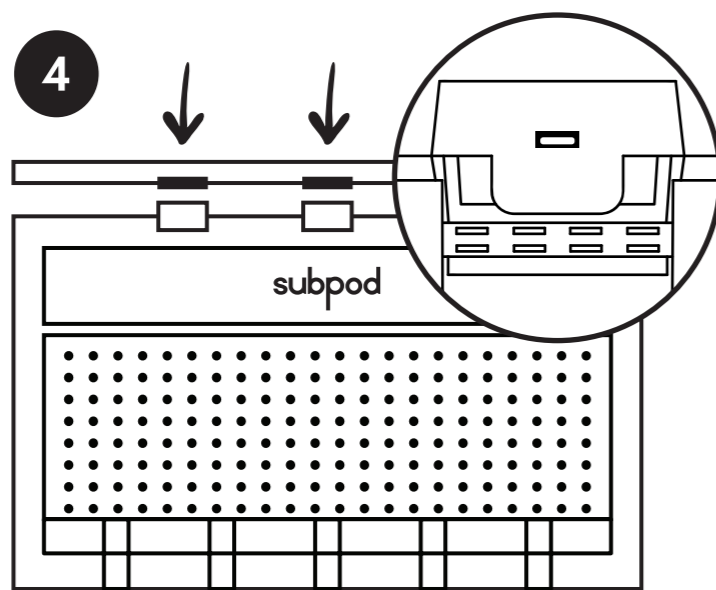

Click Lid On

Align the hinges with the lid sockets and press firmly to click them into place. Look from the inside and make sure the hinge has locked in.

Attaching the support hinge

Lean the lid against a wall to hold it upright, then follow steps 1 to 3, starting with the axle bolt at the bottom first.

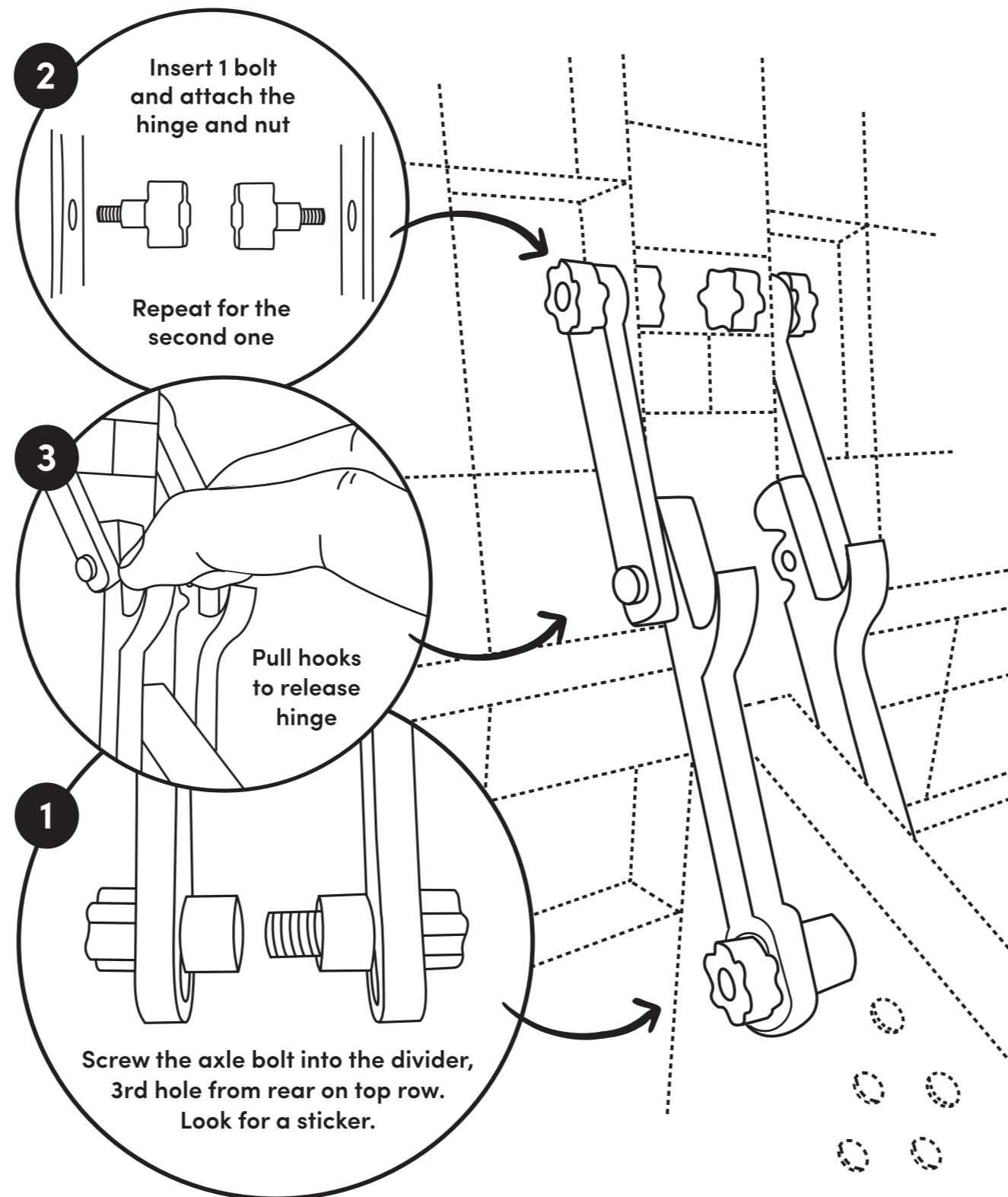

Assembly done! Before we bury the Subpod, why not take a few photos and share on social media! #subpod #compostunderground

Planting your Subpod

Let's pick a spot for your Subpod!
We recommend planting it with your herbs and veg in a raised garden bed. Remember it doubles as a seat!

Here's what you'll need:

Spade or shovel
Watering can or hose

Optional:

Spirit level
Measuring tape

Let's get digging!

You'll be digging a hole which is:

85cm L x 55cm W x 31cm D
33in. L x 22in. W x 12in. D

That's around 8-10cm (3in.) longer and wider than Subpod. It's important that the top airflow panels are above ground.

Once you're happy with the placement, check that the Subpod is level by eye (or with a spirit level) and adjust by adding or removing soil as needed.

Fill the hole around your Subpod with soil, then water it to help settle it into place. Repeat this until the soil reaches the bottom of the airflow panel.

We're aiming for a snug fit!

If you're using Subpod as a garden seat, position it closer to the edge of the garden bed. Leave a gap of 3cm (1in.) from the wall of the bed, which will allow your worms to have some 'wriggle room' through the front.

Collecting worm juice? There's an optional plumbing feature. Visit subpod.com/start to watch our step-by-step guide for setting up your plumbing.

